

FB1BDRHD FIT OFF GUIDE

STAGE 1 INSTALLATION FLOOR BOX BODY INSTALLATION

FLOOR BOX CAST IN-SITU CONCRETE

FIX BOX BODY TO SUITABLE BRACKETS OR SUPPORT STRUCTURE

FIXING OF BOX BODY AND BRACKETS BY OTHERS AS REQUIRED TO SUIT SITE CONDITIONS

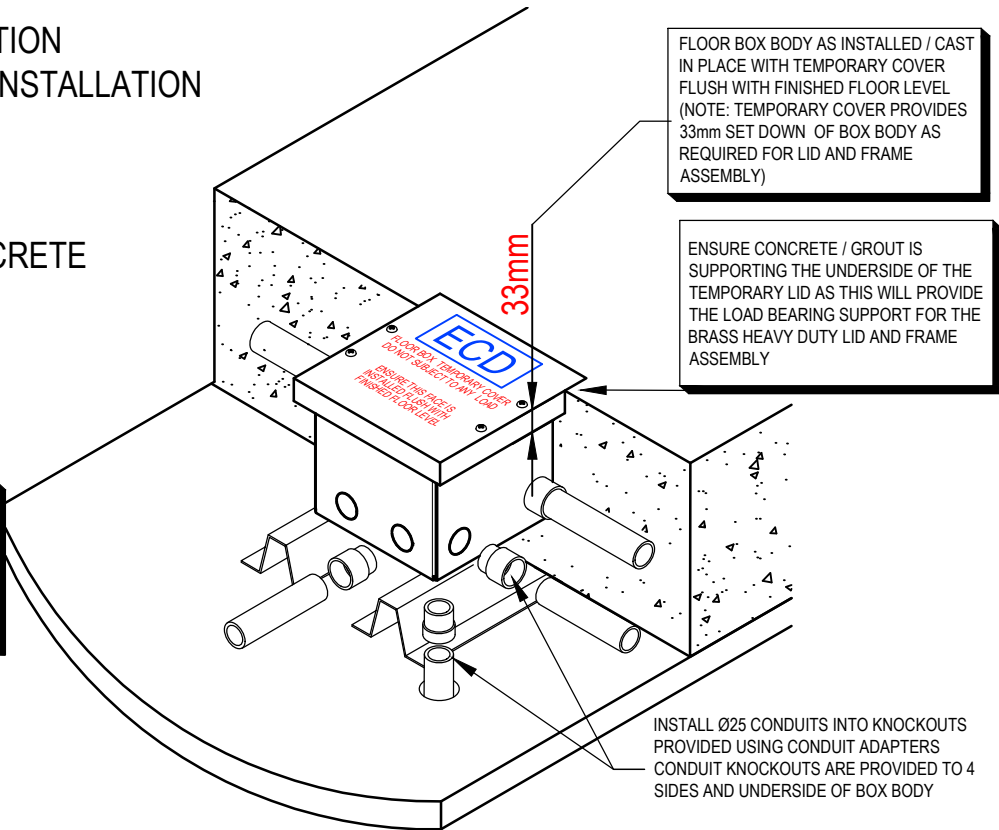

FLOOR BOX BODY AS INSTALLED / CAST IN PLACE WITH TEMPORARY COVER FLUSH WITH FINISHED FLOOR LEVEL (NOTE: TEMPORARY COVER PROVIDES 33mm SET DOWN OF BOX BODY AS REQUIRED FOR LID AND FRAME ASSEMBLY)

ENSURE CONCRETE / GROUT IS SUPPORTING THE UNDERSIDE OF THE TEMPORARY LID AS THIS WILL PROVIDE THE LOAD BEARING SUPPORT FOR THE BRASS HEAVY DUTY LID AND FRAME ASSEMBLY

INSTALL Ø25 CONDUITS INTO KNOCKOUTS PROVIDED USING CONDUIT ADAPTERS PROVIDED USING CONDUIT ADAPTERS PROVIDED USING CONDUIT ADAPTERS CONDUIT KNOCKOUTS ARE PROVIDED TO 4 SIDES AND UNDERSIDE OF BOX BODY

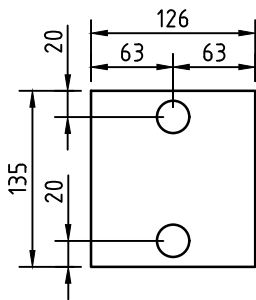

CONDUIT LOCATION
BOX BASE

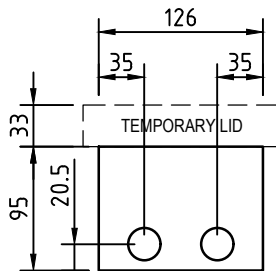

CONDUIT LOCATION
HINGE & EXIT SIDES

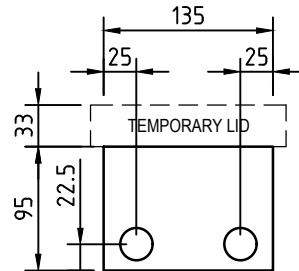

CONDUIT LOCATION
OUTLET SIDES

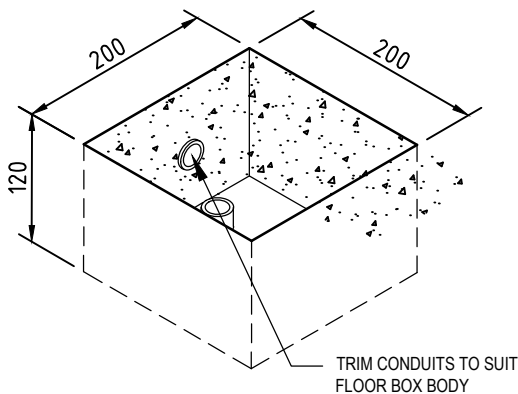

CONCRETE BLOCK OUT

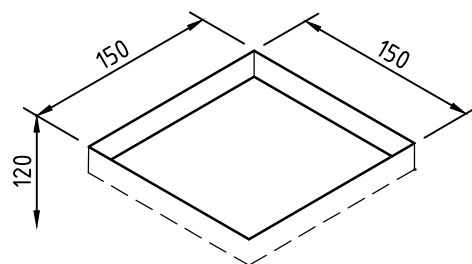

TIMBER FLOOR CUT-OUT



Electric Cable Duct Systems Pty. Ltd.

Ph: 1300 123 ECD (323) Fax: (03) 9899 5042

Email: info@ecd.net.au

www.ecd.net.au

ABN 80005544105

STAGE 2 INSTALLATION FINAL FIT OFF OF FLOOR BOX

LID AND FRAME ASSEMBLY
FIX TO FLOOR BOX WITH
4 No. M4 X 20 CSK SCREWS SUPPLIED

VOICE / DATA / AV OUTLET
MOUNTING BRACKET
FIX OUTLETS TO PLATE WITH 6
GAUGE SELF TAPPING
SCREWS PROVIDED
FIX PLATE TO BOX BODY WITH
2 No. MUSHROOM HEAD
SCREWS PROVIDED

POWER OUTLET MOUNTING
BRACKET
FIX OUTLETS TO PLATE WITH
6 GAUGE SELF TAPPING
SCREWS PROVIDED
FIX PLATE TO BOX BODY WITH
3 No. MUSHROOM HEAD
SCREWS PROVIDED

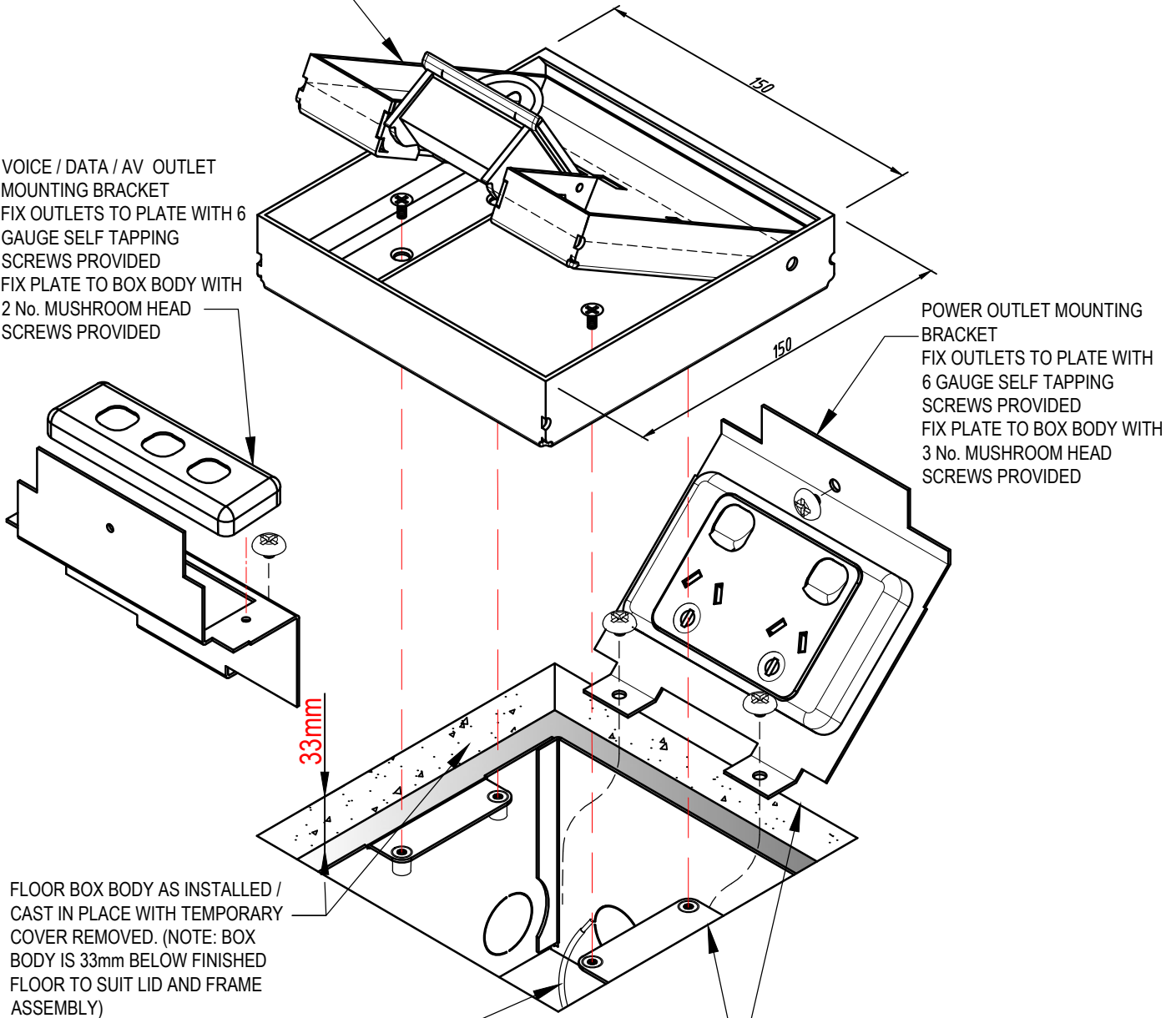

FLOOR BOX BODY AS INSTALLED /
CAST IN PLACE WITH TEMPORARY
COVER REMOVED. (NOTE: BOX
BODY IS 33mm BELOW FINISHED
FLOOR TO SUIT LID AND FRAME
ASSEMBLY)

FLOOR BOX BODY EARTH TAIL
ENSURE CONNECTION TO EARTH
CIRCUIT TO OBTAIN CORRECT EARTHING
AS REQUIRED FOR FLOOR BOX BODY

CUT CARPET/VINYL/FLOOR
COVERING TO THIS EDGE

ECD
ESTABLISHED 1979

Electric Cable Duct Systems Pty. Ltd.

Ph: 1300 123 ECD (323) Fax: (03) 9899 5042

Email: info@ecd.net.au

www.ecd.net.au

ABN 80005544105